

# VULCAN SYSTEM: The clever muscle man.

The muscle man among the hot air blowers leaves no doubts about its performance. It is compactly built and easy to integrate into industrial processes. Just as Leister's smaller hot air blowers VULCAN SYSTEM can be remote controlled through a standard analog interface.

## Hot air blower

### VULCAN SYSTEM



Technical data VULCAN SYSTEM	Frequency	
	50 Hz	60 Hz
Heating power steplessly adjustable with potentiometer	•	
Standard control interface through a 4...20 mA or a 0...10 V signal	•	
Integrated power electronics	•	
Protection against heating element or device overheating	•	
Brushless blower motor with FC control	•	
Alarm output	•	
Integrated temperature control	•	
Integrated temperature probe	•	
Display for showing the setpoint and actual values	•	
Max. air outlet temperature °C	650	
Max. air flow l/min (20°C) 3 × 230 V~	850	1500
Max. air flow l/min (20°C) 3 × 400 – 440 V~	950	1700
Static pressure kPa	3.1	4.0
Noise emission level db (A)	65	
Weight (kg)	9.3	
Mark of conformity	CE	
Protection class II	⊕	

Voltage	V ~	3 × 230	3 × 400	3 × 480			
Power consumption	kW	6	10	6	11	6	11
Order no.		143.407	143.406	143.402	140.463	143.405	143.404

#### Installation dimensions in mm

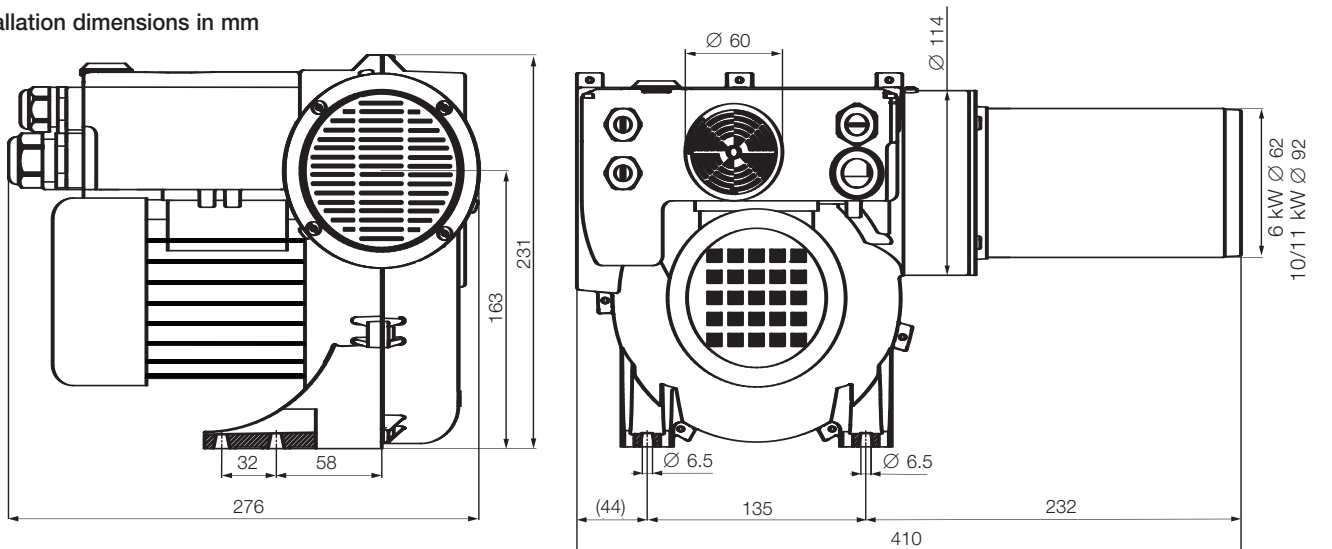

## Accessories VULCAN SYSTEM (Ø 92 mm)

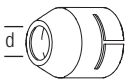
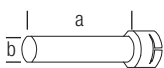
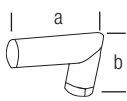
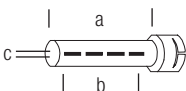
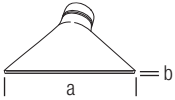
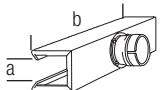
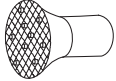
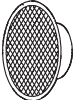
125.318		Flange connector, push-fit a = 120 mm
107.244		Round nozzle, push-fit d = 50 mm
107.273		Extension nozzle, push-fit (a x b) 500 x 60 mm
107.269		Angled nozzle, push-fit (a x b) side length 175 x 175 mm
106.031 106.035 107.268 106.036 106.033 106.038		Tubular nozzle, push-fit (a x b x c) 1000 x 800 x 2 mm 1185 x 900 x 1.6 mm 1288 x 1000 x 1.5 mm 1535 x 1250 x 1.2 mm 1550 x 1350 x 1.1 mm 2225 x 2000 x 0.8 mm
107.274 106.028 107.272 106.018 106.024 107.267 106.023 106.026		Wide slot nozzle, push-fit (a x b) 130 x 17 mm 220 x 12 mm 300 x 12 mm 400 x 10 mm 500 x 7 mm 500 x 15 mm 600 x 4 mm 600 x 9 mm
107.341		Shell reflector, push-fit (a x b) 160 x 370 mm
107.276		Sieve reflector, push-fit Ø 260 mm
107.277		Stainless steel filter, push-fit on air intake

133.517		Thermocouple holder
---------	---	---------------------

Accessories for **VULCAN SYSTEM** 6 kW (Ø 62 mm)  
see page 44.