

Leister's hot air blowers: Intelligent and flexible.

Leister's hot air blowers highlight: The new HOTWIND.



HOTWIND SYSTEM

1		Infinitely adjustable: Potentiometers for stepless adjustment of the heating and blower (PREMIUM and SYSTEM).
2		Remote controlled: Interface with alarm contact in the HOTWIND SYSTEM for controlling the air volume and heat output, using 4 – 20 [mA] or 0 – 10 [V] signal.
3		Integrated: Temperature probe in the HOTWIND SYSTEM for even greater precision.
4		User friendly: Display on the HOTWIND SYSTEM provides the user with status information.
5		Cleverly combined: Main switch with integral function button for programming (SYSTEM).
6		Cool: The unit is automatically cooled prior to switching off by pressing the function button.

	PREMIUM	SYSTEM
Heat output and air volume steplessly adjustable with potentiometer	•	•
Integrated power electronics	•	•
Protection against heating element or device overheating	•	•
Brushless blower motor	•	•
Alarm output		•
Integrated temperature control		•
Remote control interface for temperature or power set point		•
Remote control interface for air volume adjustment		•
Integrated temperature probe		•
Display for showing the setpoint and actual values (°C or °F)		•

HOTWIND PREMIUM / SYSTEM: The versatile hot air blower.

Weighing just seven pounds with its detachable handle, HOTWIND can be used both as an integrated or bench-top device. This enormous flexibility combined with the high maximum temperature of up to 800°C and the wide range of accessories means that the HOTWIND can be used in a variety of applications.

Hot air blower

HOTWIND PREMIUM / SYSTEM



Technical data HOTWIND PREMIUM / HOTWIND SYSTEM

Voltage	V~	120	230	230	230	230	230	400
Power consumption	W	2300	2300	2300	3100	3680	3680	5400
Frequency	Hz	50 / 60						
Max. air outlet temperature	°C	650	650	650	800	650	650	650
Max. air flow (20 °C)	l/min	200 – 900						
Static pressure	kPa	0.8	1.0					
Noise emission	dB(A)	< 70						
Weight without cable	kg	2.2		2.3		2.2		2.4
Dimensions		see below						
Mark of conformity		CE						
Protection class II		□						
Without connecting plug		•		•			•	•
Connecting plug (Euro)			•		•	•		
Order no. HOTWIND PREMIUM		140.095	142.612	142.643	142.608	142.609	140.098	142.644
Order no. HOTWIND SYSTEM		142.636	142.646	140.096		142.645	142.640	142.641

Subject to change without notice
Connection voltage non-switchable

Additional versions on request

Installation dimensions in mm

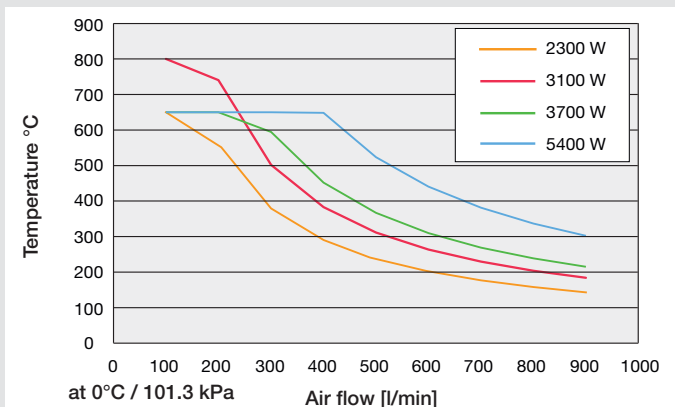
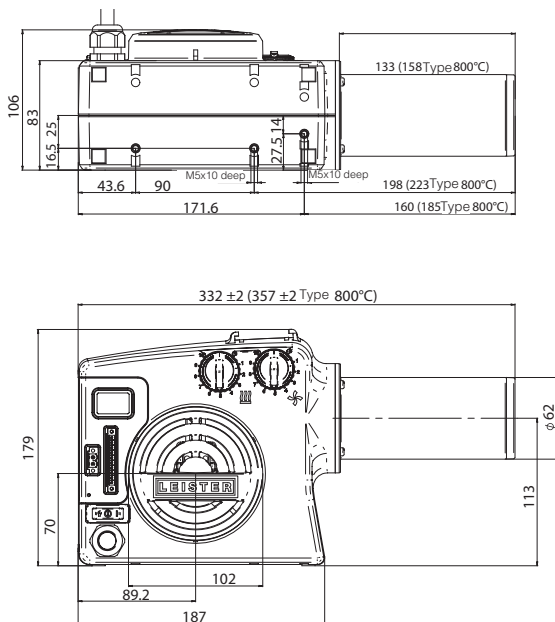



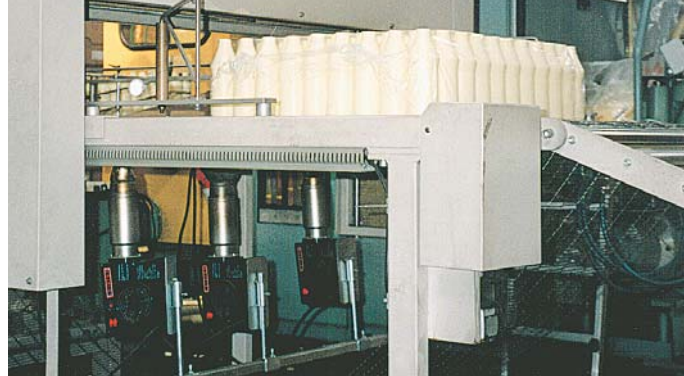



→ Accessories page 17

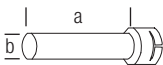
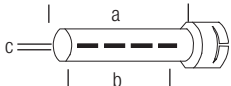
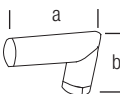

Hot air blowers shrink the film on bulky packages.

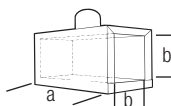
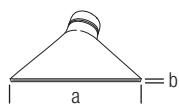
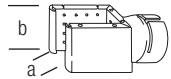
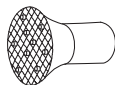
Accessories HOTWIND PREMIUM / SYSTEM (Ø 62 mm)

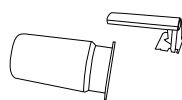
125.317		Flange connector, push-fit a = 90 mm	106.956		Temperature probe with plug 1 m cable
107.247		Extension nozzle, push-fit (a × b) 200 × 45 mm			
105.917 105.907 105.919 107.253 114.136 105.906		Tubular nozzle, push-fit (a × b × c) 303 × 153 × 6 mm 354 × 204 × 4.5 mm 456 × 306 × 3 mm 700 × 550 × 1.7 mm 795 × 655 × 1.5 mm 1100 × 1000 × 4 mm			
107.265		Angled nozzle, push-fit (a × b) shank length 120 × 112 mm			
107.245		Round nozzle, push-fit d = 40 mm			
107.342 106.174 106.175		Shell reflector, push-fit (a × b) 400 × 50 mm 400 × 65 mm 400 × 80 mm			
107.260 107.259 105.977 107.263 107.262 105.992 105.991		Wide slot nozzle, push-fit (a × b) 85 × 15 mm 150 × 12 mm 200 × 9 mm 250 × 12 mm 300 × 4 mm 400 × 4 mm 500 × 4 mm			
106.143 107.329 107.336		Sieve reflector, push-fit (a × b) 45 × 75 mm 76 × 75 mm 110 × 152 mm			
107.335		Sieve reflector, push-fit Ø 150 mm			
107.248		Stainless steel filter, push-fit on air intake			
141.723		Hand tool kit (handle and protective tube)			