

## LHS 15: Tiny but reliable.

The tiny air heater provides hot air up to 650 °C. All prominent features of Leister air heaters are also offered with this tiny heater: long-life heating element, reliable protection systems, standard interfaces. Simply summarizing – the same Leister quality as usual. This makes it a perfect tool for applications in Semiconductor, Electronics, Automotive and other industries.

### Air heater

## LHS 15



### Technical data

Max. air outlet temperature	°C	650
Max. air inlet temperature	°C	65
Max. ambient temperature	°C	80
Min. airflow		As per diagram page 27
Relative humidity	%	5 – 95 non condensing
Max. inlet pressure	kPa	100
Weight	kg	0.48
Conformity mark		CE
Protection class II		□

### Installation dimensions in mm

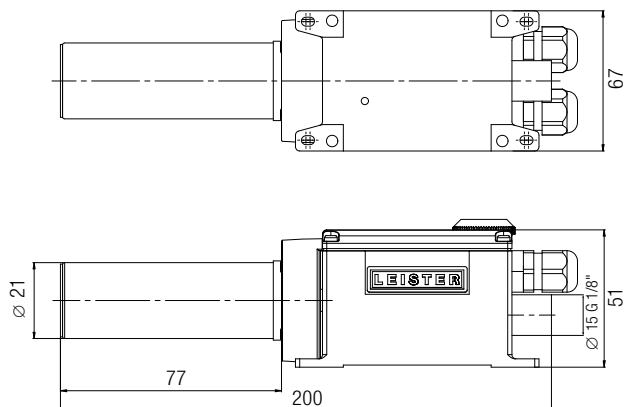

### Combination possibilities

- Leister air heater at maximum heat power and without nozzle with Leister blower at 50 Hz, 1.5 m hose length and unimpeded air outflow.
- Hot air temperature 3 mm after air outlet, measured at the hottest point.
- Air flow at 0 °C, 101.3 kPa compliant with DIN 1343.

Power Typ	Number LHS 15 x Power consumption W	Air flow l/min.	Temperature °C
ROBUST	1 × 800	1 × 150	420
ROBUST	2 × 800	2 × 130	460

Air flow and temperature values may deviate from those above based on the design of the entire hot air system (including nozzles, air hoses, environmental conditions).



Deflashing foil sleeves from charcoal filter elements with an LHS 40L air heater.

**Air heater**

**LHS 15 CLASSIC**



Heating power not adjustable

Detection of heating element and device overheating with alarm output

**Air heater**

**LHS 15 PREMIUM**



Heating power steplessly adjustable with potentiometer

Protection against heating element and device overheating with alarm output

**Air heater**

**LHS 15 SYSTEM**



Heating power or temperature steplessly adjustable with potentiometer or remote control interface

Protection against heating element and device overheating with alarm output

Remote control interface for external temperature controllers (Leister CSS, or PLC's)

Air Heaters





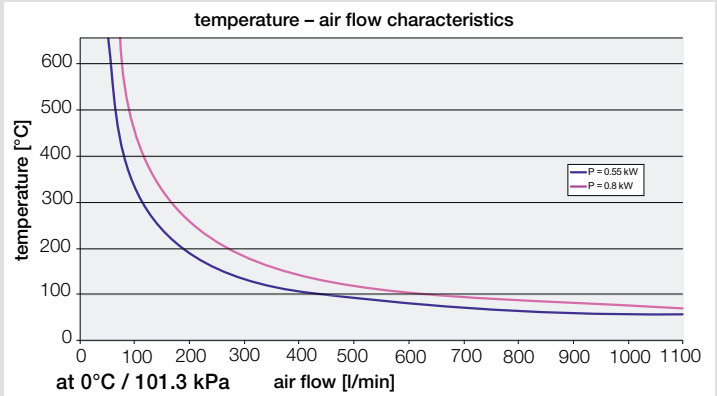



Order no.:		CLASSIC	PREMIUM	SYSTEM
LHS 15	0.55 kW / 120V	139.873	139.908	139.894
LHS 15	0.8 kW / 230V	139.874	139.893	139.895

Contact a Leister sales partner in your region for professional advice and information on our other air heaters and blowers.

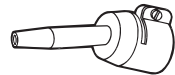

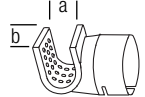
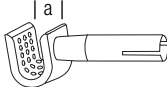
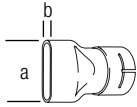
➔ Accessories page 29

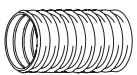
## Accessories LE MINI, LHS 15 and LE 700 (Ø 21.3 mm)

107.282		Flange connector, push-fit a = 40 mm	144.030 144.028 144.026		System interface cable 1 m 3 m 5 m one end single wires, one end RJ45
107.144 107.145		Round nozzle, push-fit Ø 5 mm Ø 10 mm			
107.152		Round nozzle, push-fit Ø 12 mm			
107.310 107.311		Sieve reflector, push-fit (a × b) 20 × 35 mm 50 × 35 mm			
107.324		Sieve reflector, push-fit on round nozzle Ø 5 mm a = 10 mm			
105.549 105.559 105.548 105.547		Wide slot nozzle, push-fit (a × b) 10 × 2 mm, angled 20 × 2 mm, length 55 mm 40 × 5 mm 50 × 8 mm			
117.955		Nozzle adapter, screw-in for nozzles LE 700 <b>&gt; LE MINI</b> <b>&gt; LE MINI SENSOR</b>			
129.407		2 m cable with plug and connection  <b>&gt; LE MINI SENSOR</b> <b>&gt; LE MINI SENSOR KIT</b>			
113.859		Air hose Ø 14 mm  <b>&gt; LE 700</b>			
144.035		Compressed air connection  <b>&gt; LHS 15</b>			
143.533		Adapter plates LHS 15 instead LE 700  <b>&gt; LHS 15</b>			