

# EMIRS200\_AT01T\_BR100

## Thermal MEMS based infrared source

For direct electrical fast modulation

TO39 header with Reflector 2

### ■ Infrared Source

Axetris infrared (IR) sources are micro-machined, electrically modulated thermal infrared emitters featuring true blackbody radiation characteristics, low power consumption, high emissivity and a long lifetime. The appropriate design is based on a resistive heating element deposited onto a thin dielectric membrane which is suspended on a micro-machined silicon structure.

### ■ Infrared Gas Detection Applications

- **Measurement principles:** non-dispersive infrared spectroscopy (NDIR), photoacoustic infrared spectroscopy (PAS) or attenuated-total-reflectance FTIR spectroscopy (ATR)
- **Target gases:** CO, CO<sub>2</sub>, VOC, NO<sub>x</sub>, NH<sub>3</sub>, SO<sub>x</sub>, SF<sub>6</sub>, hydrocarbons, humidity, anesthetic agents, refrigerants, breath alcohols
- **Medical:** Capnography, anesthesia gas monitoring, respiration monitoring, pulmonary diagnostics, blood gas analysis
- **Industrial Applications:** Combustible and toxic gas detection, refrigerant monitoring, flame detection, fruit ripening monitoring, SF<sub>6</sub> monitoring, semiconductor fabrication
- **Automotive:** CO<sub>2</sub> automotive refrigerant monitoring, alcohol detection & interlock, cabin air quality
- **Environmental:** Heating, ventilating and air conditioning (HVAC), indoor air quality and VOC monitoring, air quality monitoring

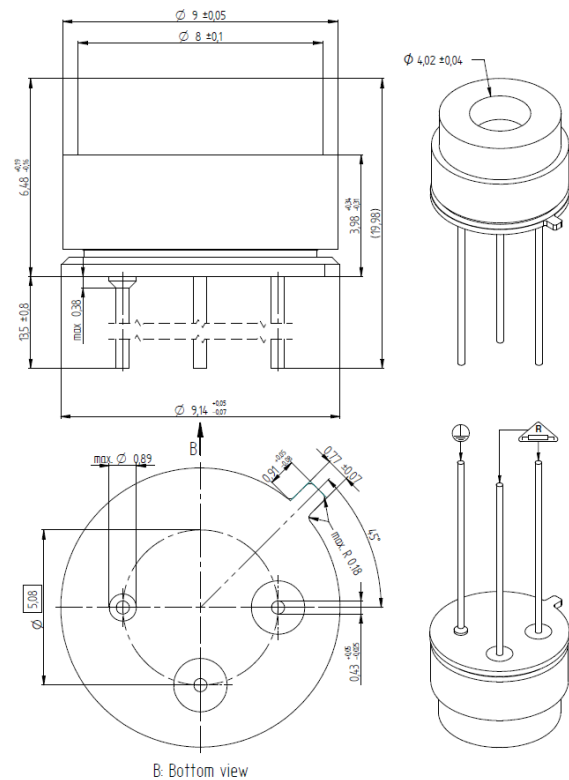

### ■ Features

- Large modulation depth at high frequencies
- Broad band emission
- Low power consumption
- Long lifetime
- True black body radiation (2 to 14 μm)
- Very fast electrical modulation (no chopper wheel needed)
- Suitable for portable and very small applications
- Rugged MEMS design

■ Absolute Maximum Ratings ( $T_A = 22^\circ\text{C}$ )

Parameter	Symbol	Rating	Unit
Heater membrane temperature <sup>1</sup>	$T_M$	500	$^\circ\text{C}$
Optical output power (hemispherical spectral) ( $T_M = 500^\circ\text{C}$ )	$P_{00}$	30	mW
Optical output power between 4 $\mu\text{m}$ and 5 $\mu\text{m}$ ( $T_M = 500^\circ\text{C}$ )	$P_{s4-5}$	4.0	mW
Optical output power between 6 $\mu\text{m}$ and 8 $\mu\text{m}$ ( $T_M = 500^\circ\text{C}$ )	$P_{s6-8}$	5.4	mW
Optical output power between 8 $\mu\text{m}$ and 10 $\mu\text{m}$ ( $T_M = 500^\circ\text{C}$ )	$P_{s8-10}$	3.3	mW
Optical output power between 10 $\mu\text{m}$ and 13 $\mu\text{m}$ ( $T_M = 500^\circ\text{C}$ )	$P_{s10-13}$	2.8	mW
Electrical cold resistance (at $T_M = T_A = 22^\circ\text{C}$ )	$R_{C22}$	35 to 55	$\Omega$
Electrical operating (hot) resistance <sup>2</sup> (at $T_M = 500^\circ\text{C}$ with $f \geq 5 \text{ Hz}$ and $t_{on} \geq 8 \text{ ms}$ )	$R_{H500C}$	$1.883 * R_{C22} - 12.02$	$\Omega$
Package temperature	$T_P$	80	$^\circ\text{C}$
Storage temperature	$T_S$	-20 to +85	$^\circ\text{C}$
Ambient temperature <sup>3</sup> (operation)	$T_A$	-40 to +125	$^\circ\text{C}$
Heater area	$A_H$	2.1 x 1.8	$\text{mm}^2$
Frequency <sup>4</sup>	$f$	5 to 50	Hz

Note: Emission power in this table is defined by hemispherical radiation. Stress beyond those listed under “absolute maximum ratings” may cause permanent damage to the device.

Note: Diagram  $R_{H500C} - R_{C22} \mid (T_M = 500^\circ\text{C})$

How to ensure that the maximum temperature for  $T_M$  is not exceeded:

1. Determine electrical cold resistance  $R_C$  of the EMIRS device at  $T_A=22^\circ\text{C}$
2. Ensure that anytime  $R_H$  does not exceed the representative limit as shown in this diagram with respect to these conditions:
  - a.  $f \geq 5 \text{ Hz}$
  - b. on-time (pulse duration)  $\geq 8 \text{ ms}$

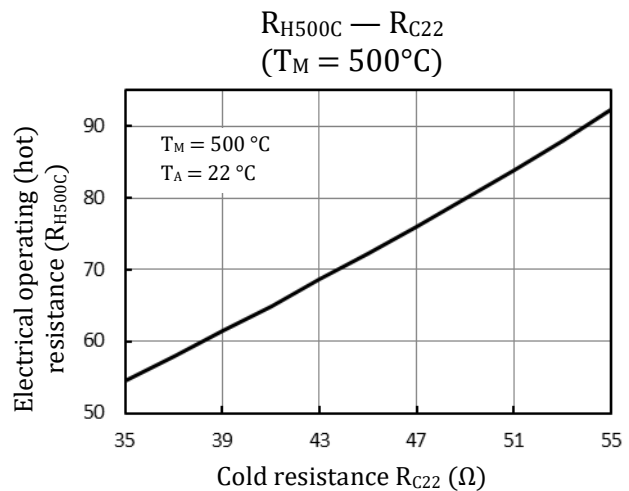

Electrical operating (hot) resistance  $R_H$  versus electrical cold resistance  $R_{C22}$  at  $T_A = 22^\circ\text{C}$

<sup>1</sup> Temperatures above  $500^\circ\text{C}$  will impact drift and lifetime of the devices.

<sup>2</sup> See Diagram  $R_H - R_C \mid (T_M = 500^\circ\text{C})$

<sup>3</sup> The environmental and package temperature might impact the lifetime and characteristic of the devices.

<sup>4</sup> Lower cut-off frequency of 5 Hz for designed thermodynamic state.

■ Ratings at Reference Operation (RO<sup>1</sup> T<sub>A</sub> = 22°C)

Parameter	Symbol	Rating	Unit
Heater membrane temperature	T <sub>M</sub>	< 500	°C
Duty cycle of rectangular V <sub>H</sub> pulse	D	62	%
Frequency of rect. pulse shape <sup>2</sup>	f <sub>ref</sub>	5	Hz
On time constant of integral emissive power P <sub>00</sub>	τ <sub>on</sub>	18	ms
Off time constant of integral emissive power P <sub>00</sub>	τ <sub>off</sub>	8	ms
Package temperature at T <sub>A</sub> = 22°C	T <sub>P</sub>	40 to 85	°C

Note: First order on-time model using τ<sub>on</sub>: First order off-time model using τ<sub>off</sub>:

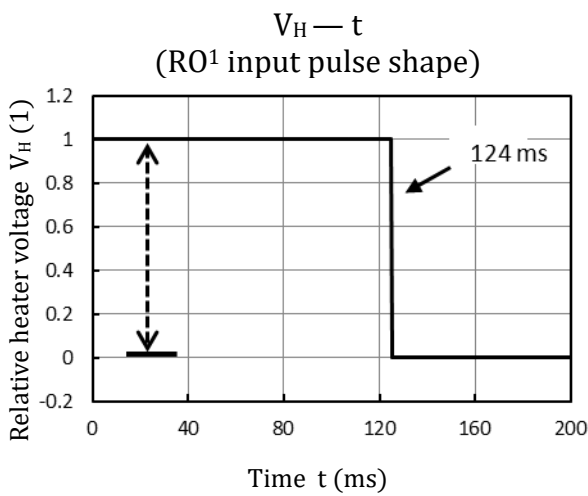

Relative rectangular heater voltage (V<sub>H</sub>) pulse with a relative pulse width of 124 ms at 5 Hz (time description of reference operation RO<sup>1</sup>)

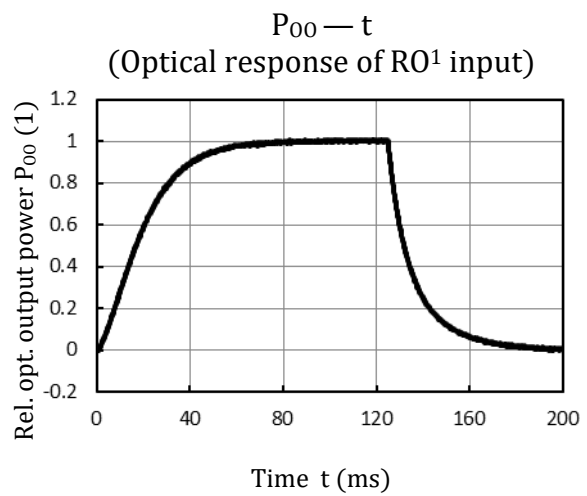

Optical response time (relative optical output power P<sub>00</sub>) of a rectangular voltage pulse (RO<sup>1</sup> conditions)

<sup>1</sup> Reference Operation: combines lower cut-off frequency of 5 Hz and maximum modulation depth (max-min signal)

<sup>2</sup> Recommended frequencies from 5 Hz to 50 Hz

■ Typical Timing Characteristics Frequency (D = 62%)

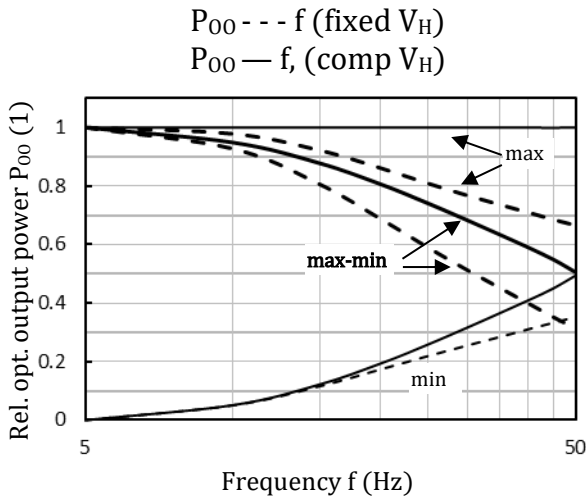

Relative (to RO) max, min, max-min values of optical output power ( $P_{00}$ ) versus frequency  $f$  with fixed and compensated  $V_H$

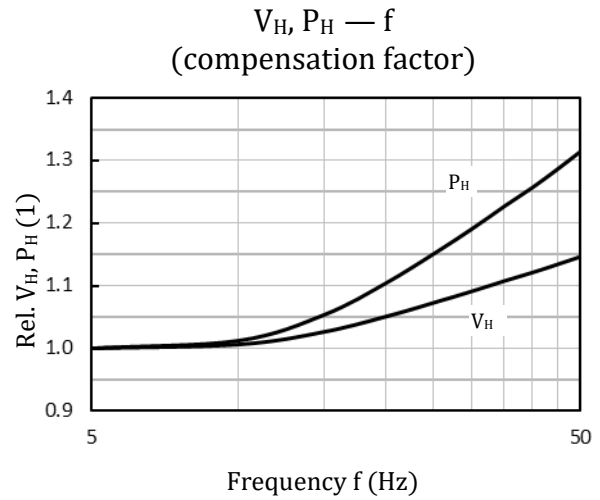

Relative (to RO) electrical drive values heater voltage  $V_H$  and power  $P_H$  versus frequency  $f$  for compensation

Note: Diagrams a, b

Relative  $P_{00}$ ,  $V_H$ ,  $P_H$  to reference operation (RO)  
 $f=5$  Hz, rect. pulse  $D=62\%$

max: maximum value of  $P_{00}$  response shape  
min: minimum value of  $P_{00}$  response shape  
max-min: amplitude calculation of  $P_{00}$  resp. shape

Fixed  $V_H$ : same voltage for all frequencies.

Compensated  $V_H$ : for every frequency value, the voltage is adjusted to achieve the same maximum of  $P_{00}$  response shape as for 5 Hz.

■ Typical Timing Characteristics Pulse Duration  $D^1$  ( $f = 50$  Hz)

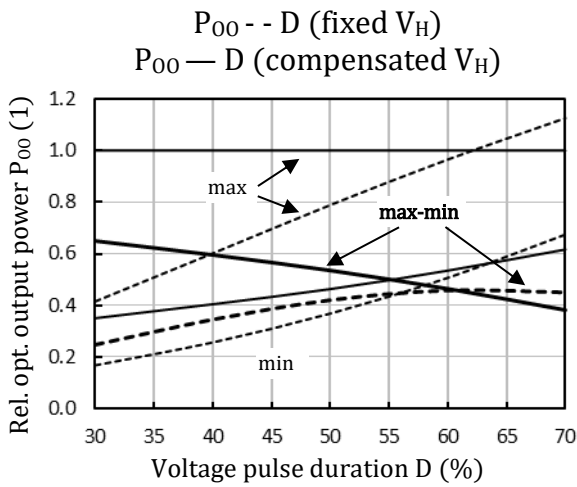

Relative (to  $D=62\%$ ) max, min, max-min values of optical output power ( $P_{00}$ ) versus duty cycle  $D$  with fixed and compensated  $V_H$

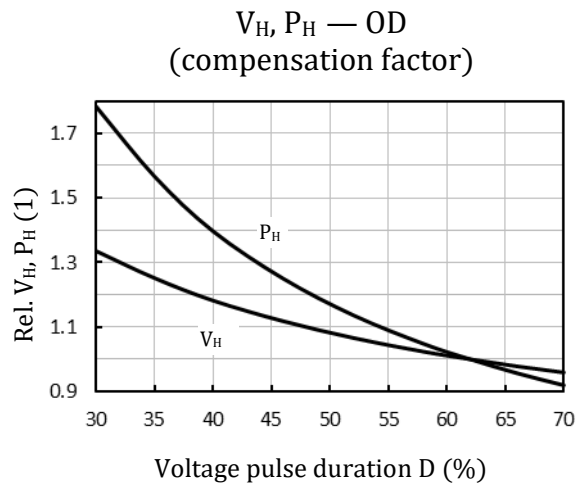

Relative (to RO) electrical drive values heater voltage  $V_H$  and power  $P_H$  versus duty cycle  $D$  for compensation

Note: Diagrams a, b

Relative  $P_{00}, V_H, P_H$  to reference operation (RO)  
 $f=50$  Hz, rect. voltage pulse

max: maximum value of  $P_{00}$  response shape

min: minimum value of  $P_{00}$  response shape

max-min: amplitude calculation of  $P_{00}$  resp. shape

Fixed  $V_H$ : same voltage for all frequencies.

Compensated  $V_H$ : for every frequency value, the voltage is adjusted to achieve the same maximum of  $P_{00}$  response shape as for  $D=62\%$ .

<sup>1</sup> Effective  $D$  shorter than 30% and voltage or power compensation at high frequencies (e.g. 20% @ 50 Hz) might impact the lifetime and characteristic of the devices because of additional stress in material layers.

■ Typical electrical/thermal characteristics (RO, T<sub>A</sub> = 22°C)

Parameter	Symbol	Rating	Unit
Peak chip membrane temperature	T <sub>M</sub>	460/500	°C
Heater voltage	V <sub>H</sub>	5.23/5.66	V
Heater power	P <sub>H</sub>	394/446	mW

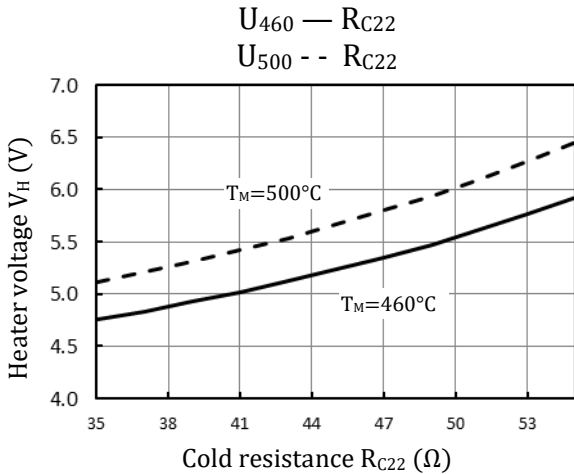

Mean<sup>1</sup> and upper bound of heater voltage V<sub>H</sub> vs. cold resistance R<sub>C22</sub>

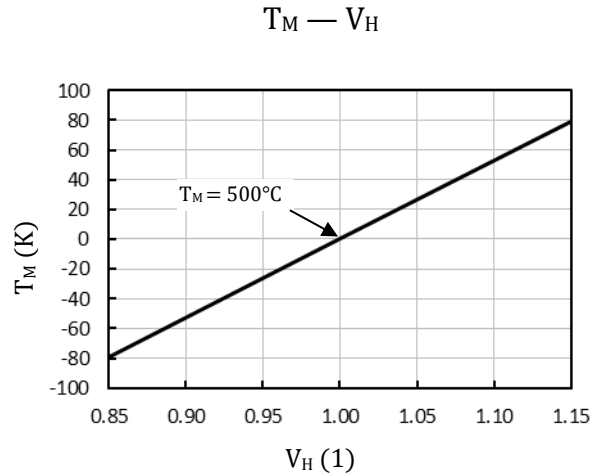

Relative change of membrane temperature (T<sub>M</sub>) by changing heater voltage (V<sub>H</sub>)

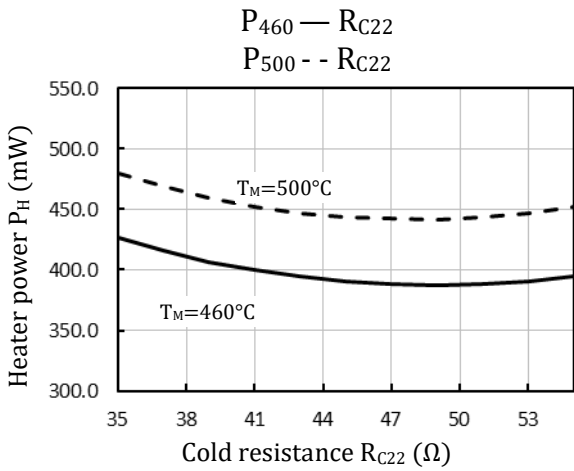

Mean<sup>1</sup> and upper bound of heater power P<sub>H</sub> vs. cold resistance R<sub>C22</sub>

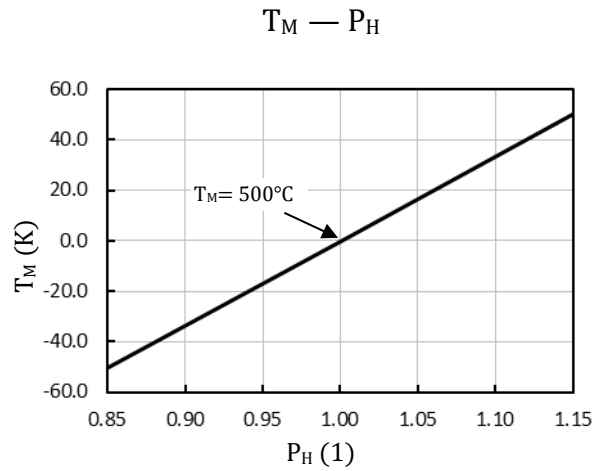

Relative change membrane temperature (T<sub>M</sub>) by changing heater power (P<sub>H</sub>)

<sup>1</sup> Recommended operation mode T<sub>M</sub> = 460°C, which ensures 95% confidence that the maximum temperature T<sub>M</sub> = 500°C is not exceeded.

■ Typical Optical Characteristics (RO,  $T_A = 22^\circ\text{C}$ )

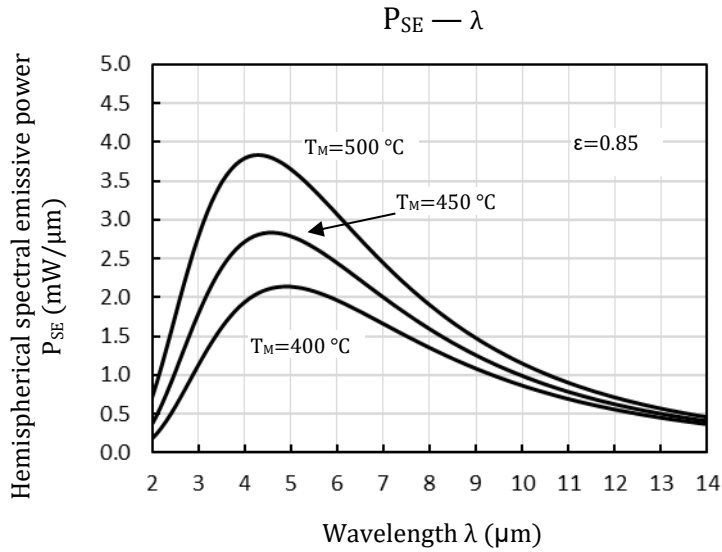

Hemispherical spectral emissive power of EMIRS200 chip surface with a typical emissivity (mean from 2 to 14  $\mu\text{m}$ ) of  $\epsilon=0.85$

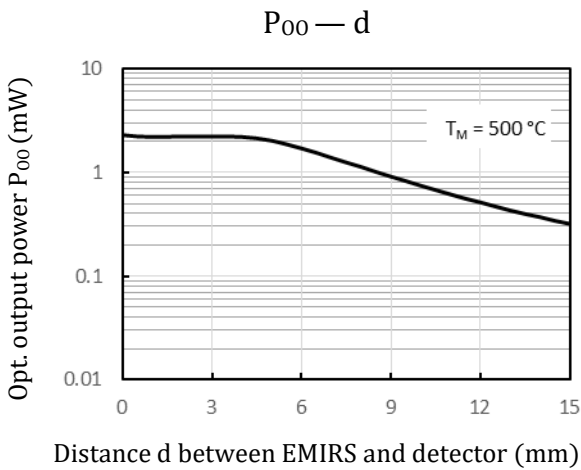

Optical output power ( $P_{00}$ ) versus distance  $d$  of a 1 mm<sup>2</sup> detection surface at 500°C  $T_M$

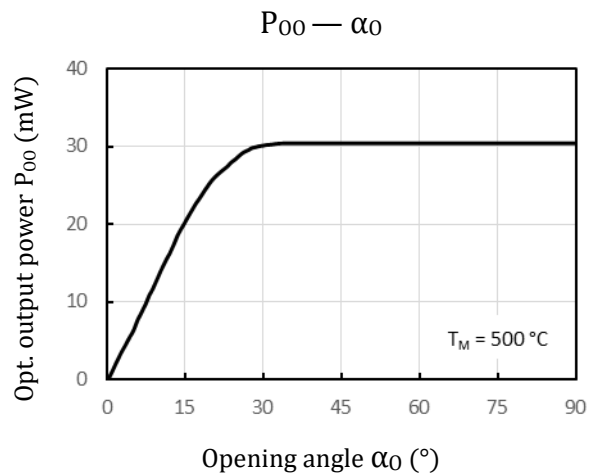

Optical output power ( $P_{00}$ ) versus opening angle  $\alpha_0$  (integral rotation of a cone) at 500°C  $T_M$

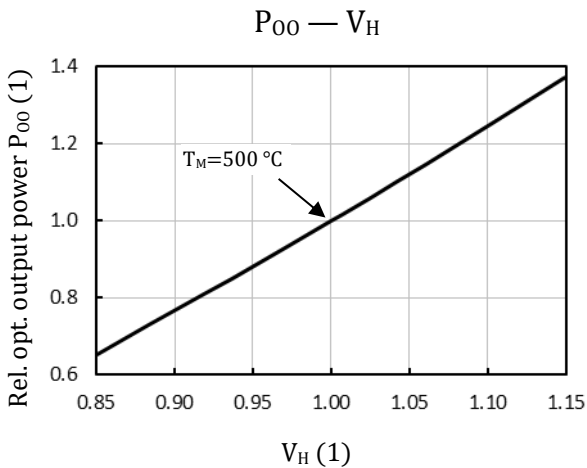

Relative change of optical output power ( $P_{00}$ ) by changing heater voltage ( $V_H$ )

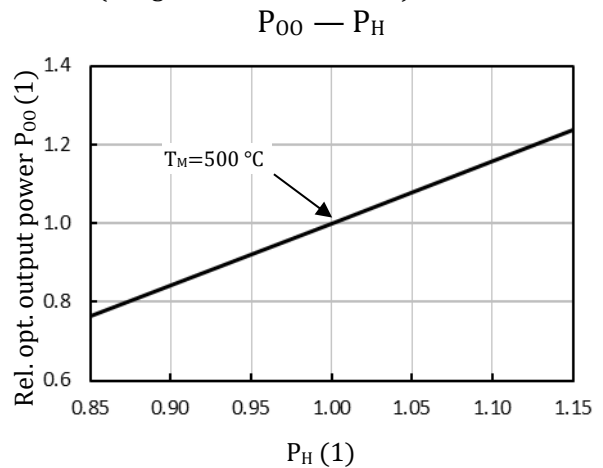

Relative change of optical output power ( $P_{00}$ ) by changing heater power ( $P_H$ )